

## DESIGN METHODOLOGY – DEMONSTRATION OF APPLICATION

W. E. Eder

*Keywords: design methodology, engineering design science, sub-problems*

### 1. Introduction

Design methods and methodologies have been suggested in various countries for many years, e.g. Pahl and Beitz [1995, 1997], Roth [1995], Koller [1979, 1985], Dierych [Hubka 1982], Hansen [1966, 1974], Hubka [1967, 1980, 1992a], Eder and Gosling [1965], VDI [1985], and others. They have received limited use in of industry [Eder 1998], but have been employed in engineering education. Subsequently, the search for design methodologies have been largely neglected, under the assumption that this development was completed, and no further improvements were likely. Creativity [Eder 1996] continued to be emphasized. The trend towards ‘integrated product development’ and ‘industrial design’ has adversely influenced the attempts to rationalize the processes of design engineering. Life-cycle engineering [Eder 2001] was independently advanced. A continuing development is based on Engineering Design Science [Hubka 1996], and is demonstrated later on a case example of *conceptualising* a large system, and one of its contributing sub-systems. This methodology is the only one that is based on a comprehensive theory in addition to experience of particular technical systems.

The regions of design engineering, integrated product development, and industrial design have much in common, but each has its distinguishing characteristics as shown in figure 1. The classes of properties of technical systems (Pr1-Pr10) in figure 1 are listed in figure 2, and provide full coverage of properties.

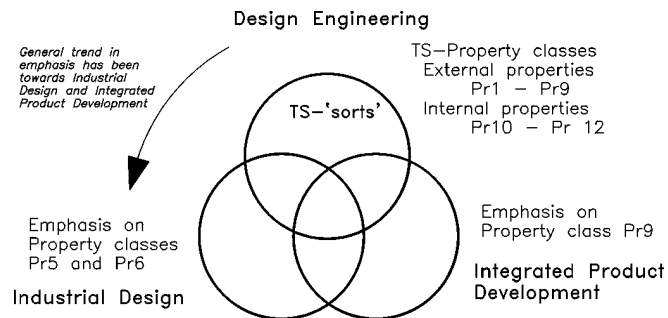

Figure 1. Scope of Sorts of Designing

Integrated product development tends towards aspects of enterprise and product management. The differences between industrial design and design engineering are now almost neglected. Yet this difference could easily be demonstrated with the help of an example. A caricature of the differences is

presented in table 1. It is acknowledged that architecture is also concerned with managing substantial projects, nevertheless, the legal liability reverts to the engineers.

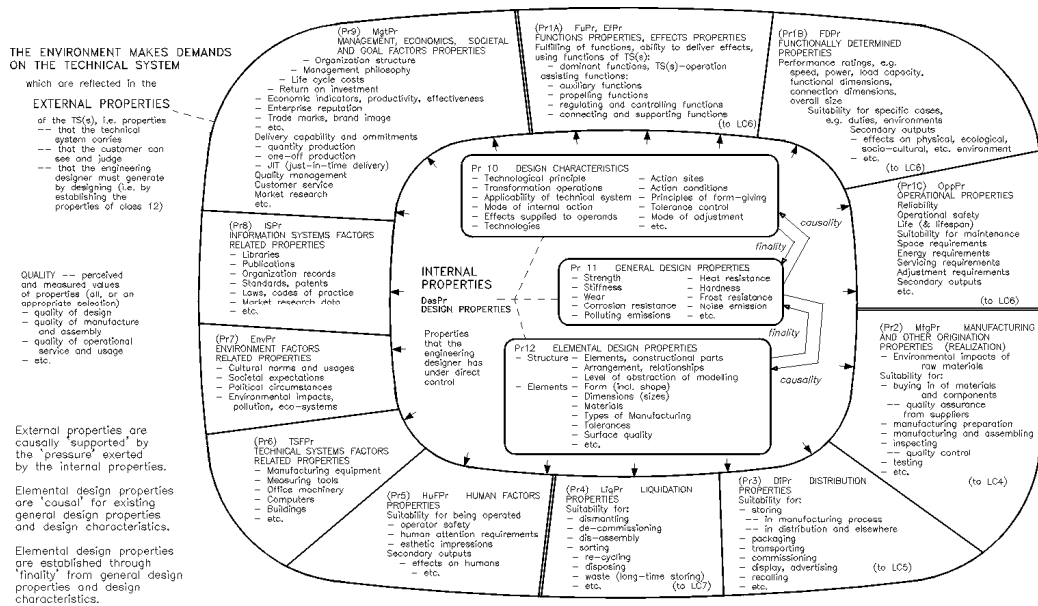

Figure 2. Relationships among External and Internal Properties of Technical Systems

Table 1. Characteristics of Designing

Research Objectives, Design Conditions	Design Engineering	Artistic-Architectural-Industrial Design
The object to be designed, or the existing (designed) object	Technical System; primary: functioning, performing a task, substantial engineering content	Product; primary: appearance, functionality
Representation and analysis of the object as designed, and its 'captured design intent'	Preparing for manufacture, assembly, distribution, etc., AI, CAD/CAM	Rendering for presentation and display, product range decisions
Design process (for the object), methodology, – generating the 'design intent'	Theories of designing, Design Science, Formal design methodologies	Intuitive, collaborative, interactive designing
Design phenomenology	Empirical, experimental and implementation studies	Protocol studies
Responsibilities	Professional, reliability, liability, safety, public, enterprise, stakeholders	Enterprise, stakeholders
Location	Design/Drawing Office	Studio

## 2. Methodology

The majority of methodologies and procedural models that have been published to date (e.g. see Introduction) show gaps that make consistent application more difficult. Most models do not show how the recommended methodology can be adapted to design engineering of variants and alterations. Life cycle engineering, quality-function-deployment, value engineering, and other published methods are hardly ever brought into context with the recommended methodology.

One basic problem is that these methodologies assume a novel design problem, and emphasize the procedure for the major design phases of 'I - clarifying the problem' and 'II - conceptualizing'. Yet most of design engineering takes place in the phases 'III - embodying' and 'IV - detailing', where much of the work is routine, computer aids to designing and information capture are useful, and simulation and optimization of existing concepts is well developed [Vajna 2005]. It is well known that about 50 to 80% of the future cost of a product is committed by selecting a concept. The remaining commitment occurs during layout/embodyment, and detailing. Nevertheless, embodying and detail design (the more routine phases) are often responsible for the failure of a product.

The developments based on Engineering Design Science [Hubka 1992b, 1996] show clearly how the gaps can be bridged. Design engineering is a processing of information [Eder 2004]. The basic model of Design Science is that of the transformation system, see figure 3.

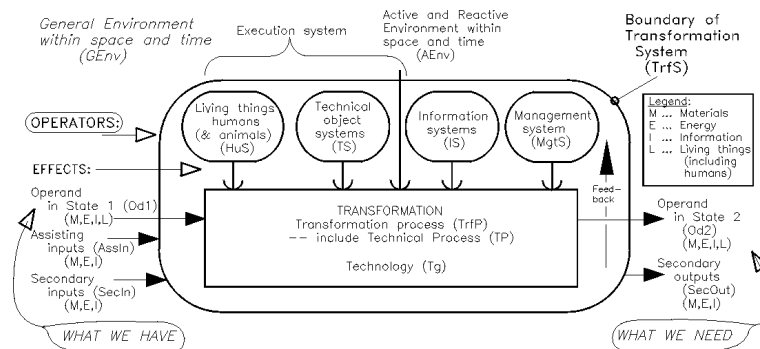

Figure 3. General Model of a Transformation System

This model declares that an *operand* (materials, energy, information and/or living things) in state Od1 is transformed into state Od2 by applying a suitable technology and using the active and reactive effects (in the form of materials, energy and/or information) exerted by the *operators* (human systems, technical systems, active and reactive environment, information systems, and management systems), whereby assisting inputs are needed, and secondary inputs and outputs can occur for the operand and for the operators.

Once this model is understood, a consistent and systematic methodology to aid creativity [Eder 1996] for novel designing of technical systems (TS) can be proposed. The methodology needs to be adapted and applied with multiple iterations, with sub-divisions of the problem and recursions, and with continuous interchange with intuitive and opportunistic actions where appropriate. The results should then be recorded in the pattern of the recommended procedural model, which should then be similar to results from systematic and methodical work. With this transformation system, designers can (for a novel transformation process or technical system to be designed) [Hubka 1988, 1992b, 1996]:

0. set up a design specification, i.e. a list of requirements and constraints for the novel system to be designed, preferably using the classes of TS-properties as shown in figure 2, and especially considering the operators of the life-cycle processes for properties Pr1, Pr2, Pr3 and Pr4 (processes LC6, LC4, LC5 and LC7), see [Eder 2006];
1. establish the desirable output (operand in state Od2) of the transformation process;
2. establish a suitable transformation process (TrfP) for the future system, establish its operations, and (if needed) suitable inputs (operand in state Od1), see figure 4; which can act

as a check-list to ensure that all necessary aspects are considered during design engineering of the TrfP;

3. decide which operations will be performed by humans, which by technical system (a technical process, TP), and which by the active and reactive environment, alone or in mutual cooperation;
4. establish which of the technical systems (or parts of them) needs to be designed at that point (i.e. does not yet exist), this will be the TS(s);
5. establish a technology for that operation for which the technical system TS(s) needs to be designed, and therefore the active or reactive effects needed from the technical system TS(s);
6. establish what the technical system TS(s) needs to do (its internal and cross-boundary functions) to produce these active or reactive effects as outputs, and what its inputs need to be. This results in the well-known function structure, with improved definition and formulation of the functions, derived from steps (1) to (5), see figure 5, and which can act as a check-list to ensure that all necessary aspects are considered. This structure can emphasize the dominant functions, but can also include as many of the assisting functions as is considered useful.;
7. establish what organs (function-carriers in principle) can perform these functions, and what added (evoked) functions and organs are recognized as needed (a function-means chain), see figure 6, another check-list – and at this point it is possible to set up a dynamic simulation model, e.g. using a four-pole model [Weber 2005a and 2005b];
8. establish which constructional parts are needed, and what additional (evoked) functions, organs, and/or constructional elements are now revealed as being needed (a more extended function-means chaining), to produce a full description of a future TS(s) in the shortest time at lowest cost. This needs a further sequence of establishing the description in sketch-outline, in rough layout, in dimensional-definitive layout, then in detail and assembly drawings. TS(s)-properties can now be evaluated with reasonable confidence, e.g. using the dynamic simulation models [Weber 2005a and 2005b], and corrections applied.

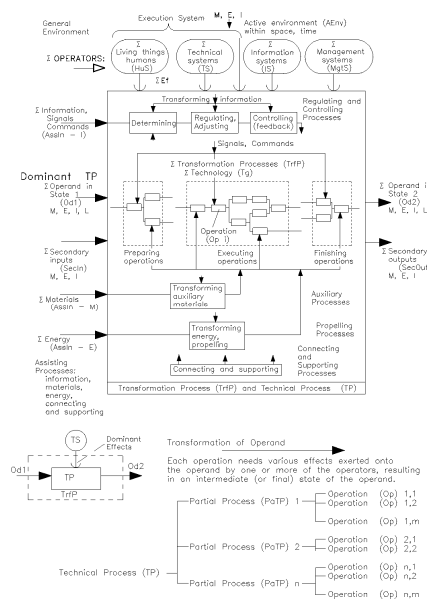

**Figure 4. Transformation Process Structure**

Only those parts of this designing process that are useful are employed. The indicated improvements have been in part published in [Hubka 1992b, 1996], but the process of improvement is continuing in cooperation with the authors of [Eder 2004].

Redesign can be accomplished by:

- establishing a design specification for the revised technical system; the technical process remains the same as for the original TS;
- analyzing the existing technical system TS(s) into its organs and (if needed) its functions;
- then following the last one or two parts of the procedure listed above for a novel system.

Consideration of life cycle issues and ‘Design for X’ advice are included in the methodology.

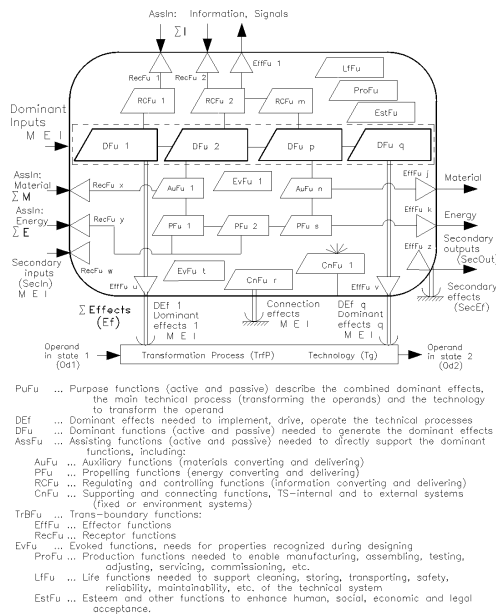

Figure 5. Function Structure for a TS

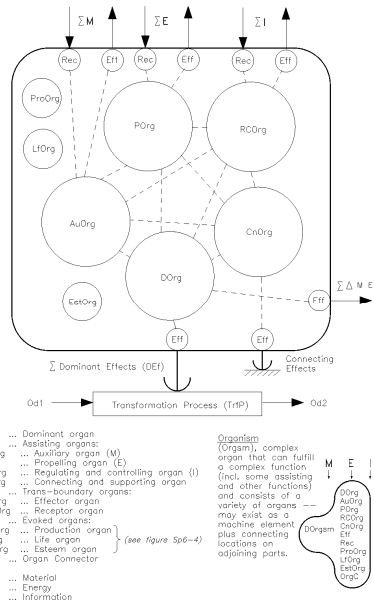

Figure 6. Organ Structure for a TS

This cannot possibly be done in a linear procedure; feedback, iteration (repeating the operations with better understanding of the problem) and recursion (dividing a problem into smaller parts, solving, then re-combining) are always needed. The possibility to search for alternative solution proposals is offered in each and every step. This seems to the author to be the essence of applied creativity. Analysis and simulation with the aid of the engineering sciences and computer applications can be applied in each step, starting from order-of-magnitude estimations of needed sizes, through static considerations for more accurate pre-establishing of sizes, up to a full dynamic simulation to verify expected behavior and suitability for the envisaged task of the technical system [Weber 2005a and 2005b]. Every step contains and should conclude with a cycle of verification, including captions such as ‘substantiate’, ‘evaluate’, ‘select’, ‘decide’, ‘verify’, ‘check’, ‘reflect’, but also ‘improve’ and ‘optimize’.

Different parts of the TS to be designed will necessarily exist at different concretisations. For instance, the high-voltage insulators, bushings and lead-throughs will likely be obtained as purchased constructional parts, selected from an engineering standard. Nevertheless, these insulators can be entered into an organ structure, using the organ representation of the insulator. They can also be entered into a function structure, e.g. using the functions ‘isolate high voltage from ground’ and ‘permit transmission of high voltage and current from one end to the other’.

### 3. Case Study - Smoke Gas Filter

As environmental requirements become progressively more severe, retro-fitting of plant to bring the operating plant up to standard happens more frequently. A thermal electric generating station needed a retro-fit for cleaning the exhaust smoke from the boilers, a smoke gas filter. The contract was given to a local enterprise which had some experience in the field, but wished to innovate for this plant, in the hope of expanding to other regions. Consequently, the enlightened management of the

enterprise asked the engineering designers to provide full documentation of their engineering design processes, so that information would not be lost for future contracts for similar equipment. The design team decided to use computer graphic and word-processing applications to document all steps and models.

**PROCEDURAL NOTE:** All steps according to the General Procedural Model of Design Engineering are listed, even if no specific result is entered for the project. The steps are outlined in section 2 of this paper, and published in [Hubka 1996].

**(P1) Establish a List of Requirements – investigate alternatives**

- P1.1 Establish rough factors for all life phases (technology, operators, inputs, outputs):*  
Transportation of the completed smoke gas filter from the organization to the plant must be possible, rail and road transport profiles, and access to the plant must be investigated.
- P1.2 Analyze life phases, establish requirements on the technical process (TP) and/or technical system TS(s):* Acceptable cleanliness of the exhaust gases should be established from the laws and standards.
- P1.3 Analyze environment of the individual life cycle processes, especially TS(s)-operational process (TP) and its users:* The filtration system must be weather-proof. All collected materials must be safely available for extraction and disposal.
- P1.4 Establish importance (priority level) of individual requirements, processes and/or operators (fixed requirements to wishes):* Several general descriptions and data were found, see references.
- P1.5 Quantify and tolerance the requirements where possible:* This power station was often used as a ‘peak-logging’ facility and ran at part-load for long periods.
- P1.6 Allocate the requirements for the TrfP and/or TS(s) to life phases, operators, and/or classes of properties*
- P1.7 Establish requirements for a supply chain, and environmental concerns*
- P1.8 Reviewed*

(P1) Output **Design Specification**, see below:

Requirements are listed only under the most relevant TS-property (see figure 2) as judged by the engineering designer, i.e. not repeated in any other relevant property class, with an indication of priority:

– F ... fixed requirement, must be fulfilled; S ... strong wish; W ... wish; N ... not considered.

Pr1) **Purpose**

- F Must accept maximum 75 m<sup>3</sup>/s of smoke gas at input temperatures 125°C to 400°C.
- F Must reduce content of particulate solids with a minimum efficiency of 95%. Particulates consist mainly of fly ash, but may also contain other contaminants.

Pr1A) **Function Properties:**

- F Must be capable of running effectively at part-load down to 1/6 power output, expected minimum smoke rate of 12.5 m<sup>3</sup>/s.

Pr1B) **Functionally Determined Properties:**

- F Must reduce content of harmful chemical agents with a minimum efficiency of 90%. These chemicals include SO<sub>2</sub> (or H<sub>2</sub>SO<sub>3</sub>), SO<sub>3</sub> (or H<sub>2</sub>SO<sub>4</sub>), CO, NO<sub>x</sub>, etc. This requirement may be deferred to a later date, when the design process for the particulate filter has progressed sufficiently.

Pr1C) **Operational Properties:**

- S Flow resistance (pressure drop) through the filter should be minimized for all flow rates.
- F Electrical safety to relevant standards, test by Underwriters laboratory and/or Canadian Standards Association, apply control symbol on rating plate.
- F Life minimum 5 years.
- S Suitable for easy maintenance

Pr2) **Manufacturing Properties:**

- F Must accommodate available manufacturing facilities.

Pr3) **Distribution Properties:**

- F Must be transportable by road and/or rail to power station site.
- Pr4) **Liquidation Properties:** No specific requirements.
- Pr5) **Human System Factors:**
  - F Access for inspection of gas channels and other parts must be provided.
  - F Safety is essential, human exposure to smoke gases and high voltage must be eliminated.
- Pr6) **Technical System Factors:**
  - S Minimum requirements on other TS (as operators) during life cycle of device.
  - S Avoid special tools for manufacture, assembly, testing, and maintenance of TS(s).
- Pr7) **Environment Factors:**
  - F No significant environmental impact for materials used in device.
  - F High energy efficiency, low energy consumption.
  - S Conform to ISO 14000:1995.
- Pr8) **Information System Factors:**
  - S Minimum requirements for information, during TS(s) life cycle, avoid special additional information (including training), provide clear user instructions.
  - S Conform to ISO 9000:1994.
- Pr9) **Management and Economic Factors:**
  - F Delivery of finished devices in 15 months from contract.
- Pr10) **Design Properties** (if any pre-specified): None

**(P2) Establish a Plan for the Design Work – investigate alternatives**

- P2.1 *Analyze and categorize the technical process TP and/or technical system TS(s) from viewpoints which influence engineering design work and planning*
- P2.2 *Select overall strategy, partial strategies and operations for important partial systems*
- P2.3 *Establish degree of difficulty of the engineering design work*
- P2.4 *Establish tasks of operators of the engineering design system, especially of individual staff members*
- P2.5 *Plan the anticipated design work, under time pressure:* Two months as target for engineering design completion, delivery of TS(s) within 15 months, target dates to be set for other stages.
- P2.6 *Estimate the engineering design costs:* Not available.
- P2.7 *Establish further goals, e.g. masters, forms, catalogs, etc.:* Precedents were available, see references.
- P2.8 Reviewed.

(P2) Output **Design Specification and Plan**

**(P3a) Establish the Transformation Process – investigate alternatives**

- P3.1 *Analyze the TS(s)-operational process - TrfP, TP:* TS(s)-operational process should accomplish main transformation, see figure 7, part A.
  - P3.1.1 *Establish input to the operational process - TP operand state Od1*
  - P3.1.2 *Establish operators of the operational process – assumed:* see figure 7, part A.
  - P3.1.3 *Establish technological principle, technology - operations, sequencing:* The main available technologies are shown in figure 7, part B. Probably the most favorable is electrostatic precipitation, see e.g. [Brad 1972, Corbitt 1990, Liu 1996].
  - P3.1.4 *Establish necessary effects acting on the operand - technology in individual operations:* This technology needs a direct-current corona, and collector plates that need frequent cleaning, see figure 7, part C.

(P3a) Output **Transformation Process - PROCEDURAL NOTE:** Compare with figure 4 to check whether any important elements may be missing.

**(P3b) Establish the TS-Function Structure**

P3.2 *Work out the complete function structure of the TS(s):* Some preliminary estimates were made using information and data from [Brad 1972, Corbitt 1990, Liu 1996]. With a flow rate of  $Q=75 \text{ m}^3/\text{s}$ , at a recommended maximum flow velocity of 2 m/s, the required flow cross-section will be  $37.5 \text{ m}^2$ . The flow velocity from the boiler was given as 5 m/s, diffusion to the lower velocity was needed. At turn-down, a flow rate of  $12.5 \text{ m}^3/\text{s}$ , and a recommended minimum flow velocity of 1 m/s, the flow cross section should be  $12.5 \text{ m}^2$ . The total cross-section can be divided into three separate sections.

The other estimates are not reported here, but they are essential to investigate the parameters of the problem.

*P3.2.1 Establish distribution of effects between humans and technical systems (and environment)*

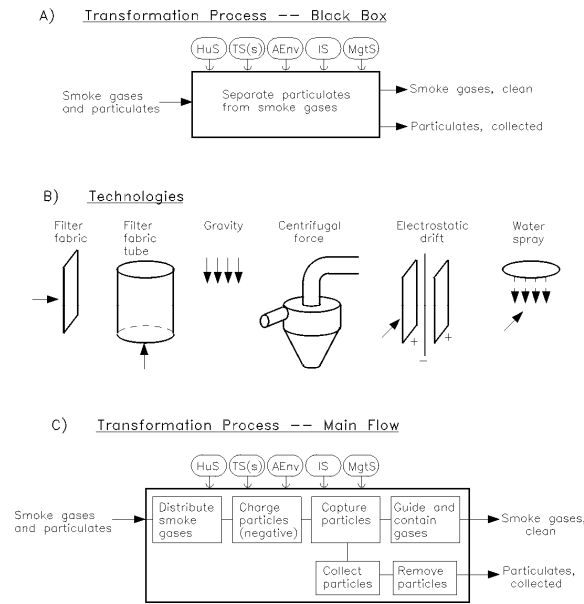

**Figure 7. Smoke Gas Filter – First Conceptualizing of Transformation Process**

*P3.2.2 Establish TS(s)-dominant functions of individual technical systems*

*P3.2.3 Allocate and distribute the dominant function among individual TS*

*P3.2.4 Establishing additional functions from an analysis of the relationships ‘human-technical system’ and ‘environment-technical system’*

*P3.2.5 Establish the assisting functions from analysis of the transformation functions: auxiliary, propelling, regulating and controlling, etc.*

*P3.2.6 Establish possibly evoked functions from important properties*

*P3.2.7 Establish TS(s)-inputs, check of TS(s)-output regarding environment*

*P3.3 Represent TS-function structures: See figure 8.*

*P3.4 Assess and evaluate the variants of the function structure: Proposed variant was approved.*

*P3.5 Reviewed*

**(P3b) Output TS-Function Structure - PROCEDURAL NOTE:** Compare with figure 5 to check whether any important elements may be missing.

**(P4) Establish the TS-Organ Structure – investigate alternatives**

*P4.1 Enter TS-functions from function structure into first column of morphological matrix*

*P4.2 Find action principles, possible modes of action*

*P4.3 Establish organs or organisms as means (function carriers): The morphological matrix is shown in figure 9.*

During development of the morphological matrix, the engineering designers recognized that some functions were too concise to be solved. Function 2 was expanded as shown in the morphological matrix, and this was transferred as amendment A) to the function structure, figure 8. Function 7 was also expanded and transferred as amendment B). Function 6 was anticipated to need expansion, shown as amendment C).

The project could at this point be recursively separated into smaller, relatively self-contained portions. The functions 8, 9, 10, 11, 12, 13 and 14 were considered suitable for separate treatment, e.g. by a smaller team. Co-ordination of teams must be a high priority, decisions by one team usually affect the problems faced by other teams.



**PROCEDURAL NOTE:** The procedure of separation demonstrates the recursive repeat of the full procedure. For instance, Function 8 ‘Force particles off collector plates’, can be formulated in a design specification statement of:

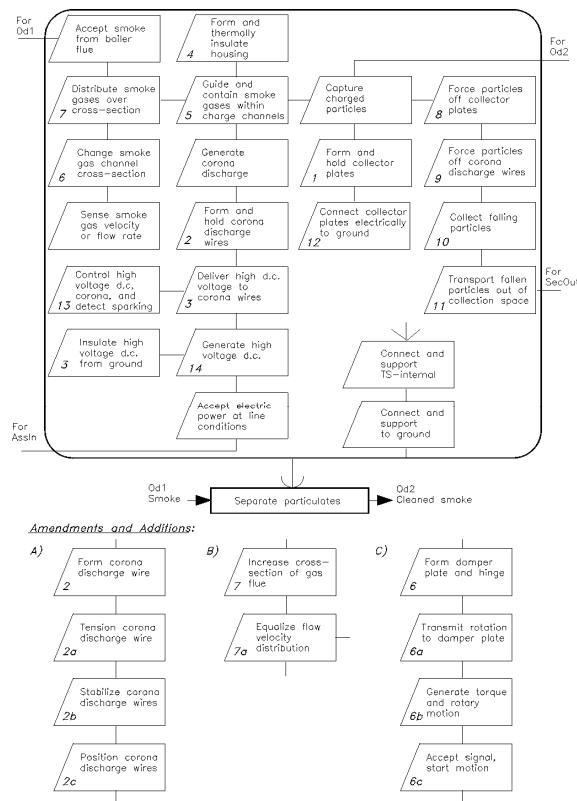

**Figure 8. Smoke Gas Filter – Function Structure**

**Pr1) Purpose for Function 8:**

F Must, at set or variable time intervals, provide vibration to collector plates and wire discharge electrodes to dislodge the accumulated particle material. The operand for this sub-problem is ‘smoke particles (fly ash)’ in state Od1 ‘on the plate’, in state Od2 ‘off the plate’. If desired, the structure models from this recursion could be combined with the models for the main TS(s), but may make the models too complicated for easy review and understanding.

Continuation of project “Smoke Gas Filter”:

- P4.4 Combine individual organs to a unity (a proposed organ structure)
- P4.5 Evaluate organ structure proposals and select the best
- P4.6 Establish assisting functions and their organs, and evoked functions for organs where needed
- P4.7 Examine evoked secondary outputs and necessity of further organs
- P4.8 Establish functions of complex organs, action locations
- P4.9 Establish fundamental situations and orders (topology, arrangement): Combined treatment
- P4.10 Represent final technical system proposals as organ structures with enough detail for evaluation and selection: The designer attempted several combinations of organs to solve groups of functions, see figure 10. The results for functions 2 and 3 revealed that 12 arrangements could be identified, depending on which header was combined with which corona wire support and tensioning. Evaluation by weighted point rating was performed, see figure 11.

P4.11 Reviewed

(P4) Output **Organ Structure - PROCEDURAL NOTE:** Compare with figure 6 to check whether any important elements may be missing.

(P5a) **Establish the Constructional Structure (1) - investigate alternatives**

Function	No	Principles, Partial Organs			
Form and hold collector plates	1	Flat plate	Wavy plate	Shielded plate	Pocket plate
Form corona discharge wires	2	Round wire	Square wire (twisted)	Strip (punch-sheared)	
Tension corona discharge wires	2a	Weight suspended	Spring tensioned	Frame mounting Screw (turn-buckle)	Cross-bar supports
Stabilize corona discharge wires	2b	Stabilizing bar and loops	Stabilize frame at lower end		
Position corona discharge wires	2c	Support bar for corona wire	Top bar of frame of function 2a		
Deliver high d.c. voltage to corona wires	3	Bus-bar in air space, solid support insulators, clearance holes for high voltage d.c. leads down to support bar for corona wire	Transformer-style ceramic bushing to lead high voltage d.c. to bus-bar in smoke space, distribute to support bars for corona wires		
Form and thermally insulate housing	4	Outer shell to contain all working parts, prevent escape of smoke gases, support to ground, allow access (doors and stairs) for inspection, reduce temperature drop of smoke gases, etc.			
Guide and contain smoke gases within charge channels	5	Baffles (a) at top of collector plates between corona wires (b) at base of collector plates shaped to allow particles to fall down into particle collecting space (c) at housing sides to deflect smoke gases from side to end charging channel			
Change smoke gas channel cross-section	6	Dampers hinged at channel ends	Dampers hinged at outer walls		
Distribute smoke gases over cross-section	7	Long flared tube (about 5°)	Short increase in cross-section with splitter plates		
	7a	None	Perforated plate across flow direction	Flow straightener tubes as for wind tunnels	
Force particles off capture plates	8	Sub-project Sp12.3.1, see below			
Force particles off corona discharge wires	9	Sub-project Sp12.3.2 not completed for this example			
Collect falling particles	10	Sub-project Sp12.3.3 not completed for this example			
Transport fallen particles out of collector space	11	Sub-project Sp12.3.4 not completed for this example			
Connect collector plates electrically to ground	12	Sub-project Sp12.3.5 not completed for this example			
Control high d.c. voltage, corona, and sparking	13	Sub-project Sp12.3.6 not completed for this example			
Generate high voltage d.c.	14	Sub-project Sp12.3.7 not completed for this example			

Figure 9. Smoke Gas Filter – Morphological Matrix

P5.1 **Establish and Analyze the Requirements for the Constructional Structure and Constructional Parts:** Further work towards a preliminary layout needs more detailed information, e.g. see [Oglesby 1978], and is beyond the scope of this case example.

The subsequent stages and steps from the recommended engineering design procedure appear to be routine work for design engineering. The importance of good embodiment and detail design work in these further stages and steps is fully acknowledged, many failures of products stem from faulty design in routine work. Nevertheless, in order to conserve space in this paper, we have chosen not to complete these stages and steps.

(P5a) Output **Preliminary Layouts**

(P5b) Output **Constructional Structure**

(P6) Output **Manufacturing Documentation**

#### 4. Closure

A need obviously exists to apply a formal, systematic and methodical engineering design strategy, a methodology, at least to present the ‘design intent’ in a coherent way that can be checked, verified and retrieved. This paper and its case study show a clear procedure and recording for a complex piece of equipment, as model for application of the knowledge contained in Design Science [Hubka 1996].

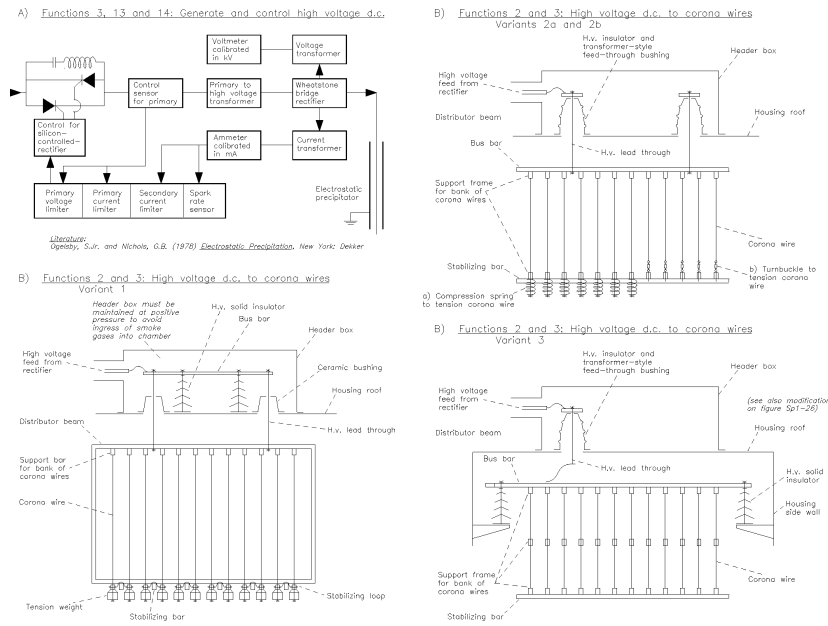

Figure 10. Smoke Gas Filter – Organ Structure

**Legend:**  
 Combinations of solution proposals from figure Sp12-26:  
 A ... Bus bar in header, support insulators in header, variation 1 upper  
 B ... Bus bar in housing, multiple feed-through bushings as support insulators, variation 2 upper  
 C ... Bus bar in housing, support insulators in housing, variation 3 upper  
 ... Corona wires tensioned by weights, variation 1 lower  
 2 ... Corona wires tensioned by compression springs, variation 2a lower  
 3 ... Corona wires tensioned by turn-buckles, variation 2b lower  
 4 ... Corona wires supported along length by frame members, variation 3 lower

**Selection criteria:**  
 0 ... Accuracy of positioning corona wires between collector plates  
 1 ... Consistency and sensitivity of tensioning of corona wires  
 2 ... Possible problems of contamination, e.g. of insulators  
 3 ... Additional facilities needed, e.g. air ballast for sealing  
 4 ... Housing space requirements  
 5 ... Overall complexity of installation  
 6 ... Potential reliability  
**Results:**  
 W ... Weighting of criteria: 1 lowest priority, 10 highest priority  
 R ... Rating of solutions: 1 worst, 5 best  
 % ... Percentage of ideal (total weight = best rating = 265)

Criterion	Solution Proposal Combination																								
	A-1		A-2		A-3		A-4		B-1		B-2		B-3		B-4		C-1		C-2		C-3		C-4		
	W	R	W	R	W	R	W	R	W	R	W	R	W	R	W	R	W	R	W	R	W	R	W	R	
a	10	4	40	5	50	5	50	5	50	4	40	5	50	5	50	5	50	4	40	5	50	5	50	5	50
b	10	5	50	6	60	4	40	5	50	5	50	5	50	4	40	5	50	5	50	5	50	4	40	5	50
c	8	4	32	4	32	4	32	4	32	5	40	5	40	5	40	5	40	2	16	2	16	2	16	2	16
d	7	4	28	4	28	4	28	4	28	5	35	5	35	5	35	5	35	5	35	5	35	5	35	5	35
e	7	4	28	4	28	4	28	4	28	5	35	5	35	5	35	5	35	3	21	3	21	3	21	3	21
f	6	2	12	3	18	3	18	4	24	3	18	3	18	3	18	4	24	4	24	4	24	4	24	4	24
g	5	4	20	4	20	4	20	4	20	5	25	5	25	5	25	5	25	3	15	3	15	3	15	4	20
Total	53		210		226		216		232		243		243		243		259		201		211		201		222
%			74.2		85.3		81.3		87.5		91.7		95.5		91.7		97.7		75.8		79.6		75.8		83.8
Rank			11		6		8		5		3+		2		3-		1		10-		9		10-		7

**NOTE:** Variant C could be improved (e.g. by wire guide bar criterion 2) by adding the solid insulator at an angle, the angle of the insulator being the closer to the corona wire support, allowing sufficient clear distance between the corona wire support and the housing side wall, see diagram above.

Figure 11. Smoke Gas Filter – Evaluation

References

Brad, R.G., Straub, C.P., and Prober, R. (eds.) (1972) *CRC Handbook of Environmental Control Vol 1 – Air Pollution*, Boca Raton, FL: CRC Press, pp. 448-451 and 550-555

Corbitt, R.A. (ed.) (1990) *Standard Handbook of Environmental Engineering*, New York: McGraw-Hill, pp. 4.42-4.49

Eder, W.E., and Gosling, W. (1965) *Mechanical Systems Design, Commonwealth and International Library # 308*, Pergamon Press, Oxford

Eder, W.E., (1995) 'Engineering Design – Art, Science and Relationships', *Design Studies*, 16, p. 117\_127

Eder, W.E. (ed) (1996) *WDK 24 – EDC – Engineering Design and Creativity – Proceedings of the Workshop EDC, Pilsen, Czech Republic, November 1995 Zürich: Heurista*

Eder, W.E. (1998) 'Design Modeling -- a Design Science Approach (and Why Does Industry Not Use It?)', *Journal of Engineering Design*, Vol 9, No 4, pp 355-371

Eder, W.E. (2001) 'Designing and Life Cycle Engineering - A Systematic Approach to Designing', *Proc. Inst. Mech. Eng. (UK), Part B, Jnl. of Engineering Manufacture*, Vol 215, No B5, 2001, p. 657-672

- Eder, W.E. (2003) 'A Typology of Designs and Designing', in *DS 31 – Proc. ICED 03 Stockholm*, p. 251-252 (Executive Summary), full paper number 1004 on CD-ROM, The Design Society
- Eder, W.E. and Hosnedl, S. (2004) 'Information – a Taxonomy and Interpretation', in *Proc. International Design Conference - Design 2004, Dubrovnik, May 18 - 21, 2004*, p. 169-176.
- Eder, W.E. and Hosnedl, S. (2006) 'Properties of Technical Systems – Revisited', in review for *Proc. International Design Conference - Design 2006, Dubrovnik, May 15 - 18, 2006*
- Hansen, F. (1966) *Konstruktionssystematik (Design Systematics)* (2. ed.), Berlin: VEB Verl. Technik
- Hansen, F. (1974) *Konstruktionswissenschaft – Grundlagen und Methoden (Design Science – Basis and Methods)*, München: Carl Hanser
- Hubka, V. (1967) 'Der grundlegende Algorithmus für die Lösung von Konstruktionsaufgaben' (Fundamental Algorithm for the Solution of Design Problems) in *XII. Internationales Wissenschaftliches Kolloquium der Technischen Hochschule Ilmenau, Heft 12 Sektion L - Konstruktion, Ilmenau: T.H.I.*, p. 69\_74
- Hubka, V. (1980) *WDK 1: Allgemeines Vorgehensmodell des Konstruierens*, Goldach: Fachpresse.
- Hubka, V. (ed.) (1982) *WDK 9: Dietrych zum Konstruieren (Dietrych about Designing)*, Zürich: Heurista
- Hubka, V. & Eder, W.E. (1988) *Theory of Technical Systems*, Berlin: Springer-Verlag
- Hubka, V. (1992a) *Engineering Design*, Zürich: Heurista
- Hubka, V. and Eder, W.E. (1992b) *Einführung in die Konstruktionswissenschaft (Introduction to Design Science)*, Berlin, Springer-Verlag
- Hubka, V., & Eder, W.E. (1996) *Design Science: Introduction to the Needs, Scope and Organization of Engineering Design Knowledge*, London: Springer-Verlag, <http://deed.ryerson.ca/DesignScience/>
- Koller, R. (1979) *Konstruktionsmethode für Maschinen-, Geräte- und Apparatebau (Design Method for Machine, Device and Apparatus Construction)*, Berlin/Heidelberg: Springer-Verlag
- Koller, R. (1985) *Konstruktionslehre für den Maschinenbau (Study of Designing for Mechanical Engineering, 2. ed.)*, Berlin/Heidelberg: Springer-Verlag
- Liu, D.H.F., and Liptak, B.G. (eds.) (1996) *Environmental Engineers' Handbook (2 ed.)*, Boca Raton, FL: Lewis Publ., pp. 353-361
- Müller, J. (1990) *Arbeitsmethoden der Technikwissenschaften – Systematik, Heuristik, Kreativität (Working Methods of Engineering Sciences, systematics, heuristics, creativity)*, Berlin: Springer-Verlag
- Oglesby, S.Jr., and Nichols, G.B. (1978) *Electrostatic Precipitation*, New York: Marcel Dekker
- Pahl, G., & Beitz, W. (1995) *Engineering Design (2 ed.)*, London: Springer-Verlag (1 ed 1984) (Edited and translated by K. Wallace, L. Blessing and F. Bauert), translated from 1993-3rd ed
- Pahl, G., & Beitz, W. (1997) *Konstruktionslehre, Methoden und Anwendungen, (4 ed.)* Berlin/Heidelberg: Springer-Verlag (1 ed. 1977, 2 ed 1988, 3 ed 1993)
- Roth, K. (1995) *Konstruieren mit Konstruktionskatalogen (2 ed. 2 vols.) (Designing with Design Catalogs)*, Berlin/Heidelberg: Springer-Verlag (1 ed 1982)
- Vajna, S., Clement, S., Jordan, A. & Bercsey, T. (2005) 'The Autogenic Design Theory: an evolutionary view of the design process' *Journal of Engineering Design*, Vol. 16, No. 4, August 2005, p. 423-440
- VDI (1985) *VDI Richtlinie 2221: Methodik zum Entwickeln und Konstruieren technischer Systeme und Produkte (Methodology for Developing and Designing Technical Systems and Products)*, Düsseldorf: VDI
- Weber, C. (2005a) 'Simulationsmodelle für Maschinenelemente als Komponenten mechatronischer Systeme', in *Proc. IWK 2005 – Internationales Wissenschaftliches Kolloquium, Technische Universität Ilmenau, 19.-23. Sept. 2005*, on CD-ROM
- Weber, C. (2005b) 'Simulation Models of Machine Elements as Components of Mechatronic Systems', in *Proc. AEDS 2005 Workshop, The Design Society – Special Interest Group Applied Engineering Design Science, 3 – 4 Nov. 2005, Pilsen, Czech Republic*, on DC-ROM

W. Ernst Eder, MSc, Professor Emeritus, Dr.h.c. (University of West Bohemia in Pilsen, Czech Republic)  
 Royal Military College of Canada, Department of Mechanical Engineering  
 Home Address: 107 Rideau Street, Kingston, Ontario, Canada K7K 7B2  
 Tel.: x-1-613-547-5872  
 Email: eder-e@rmc.ca